

自夹紧式密封胶条 Self-gripping Gasketing

产品系列：7201、7202、7203

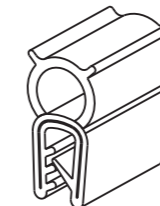
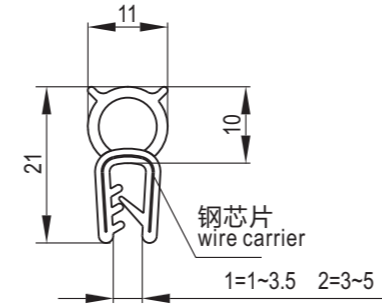

黑色发泡EPDM密封胶条
Sponge-rubber,black epdm gasket

Ts	
1~3.5	7201-211
3~5	7201-212

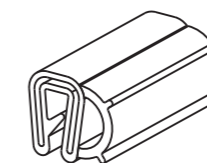
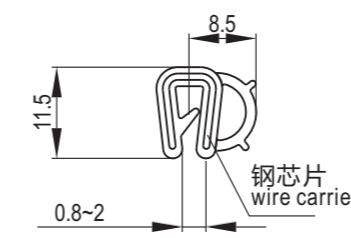
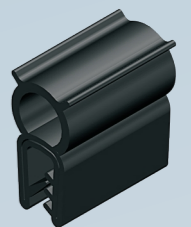

黑色发泡EPDM密封胶条
Sponge-rubber,black epdm gasket

	7202-115
--	----------

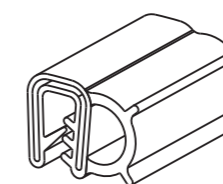
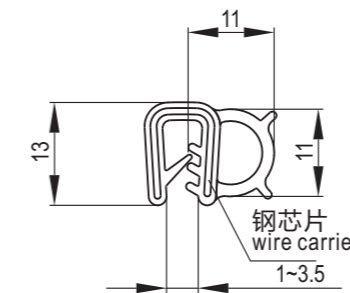
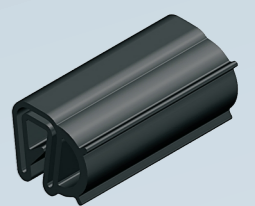

黑色发泡EPDM密封胶条
Sponge-rubber,black epdm gasket

	7203-13
--	---------

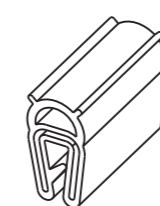
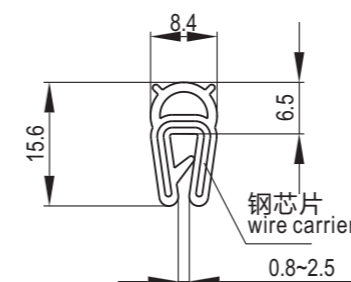
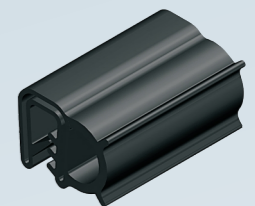

黑色发泡EPDM密封胶条
Sponge-rubber,black epdm gasket

	7203-156
--	----------

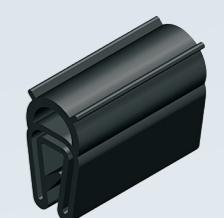

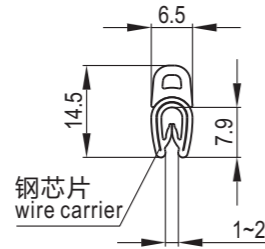

钢芯片
wire carrier

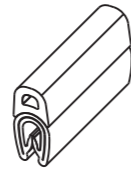

黑色发泡EPDM密封胶条
Sponge-rubber, black epdm gasket

7204-145

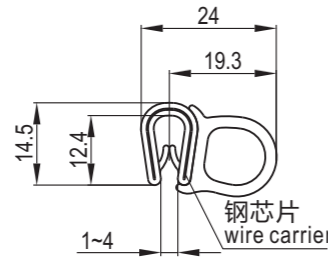
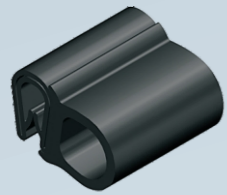

钢芯片
wire carrier

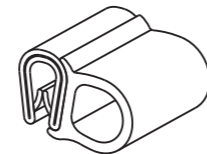

黑色发泡EPDM密封胶条
Sponge-rubber, black epdm gasket

7205-145

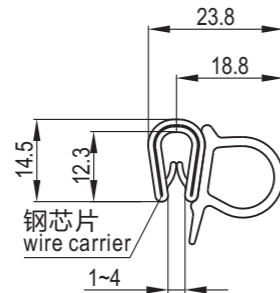
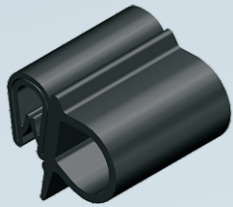

钢芯片
wire carrier

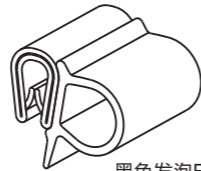

黑色发泡EPDM密封胶条
Sponge-rubber, black epdm gasket

7206-145

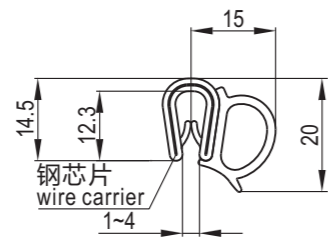
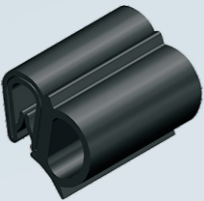

钢芯片
wire carrier

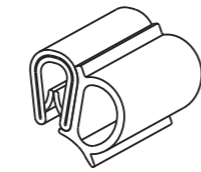

黑色发泡EPDM密封胶条
Sponge-rubber, black epdm gasket

7207-145

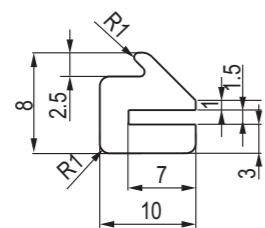
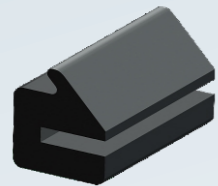

黑色发泡EPDM密封胶条
Sponge-rubber, black epdm gasket

7404-10

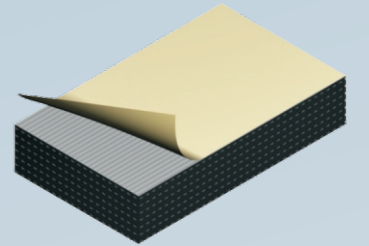
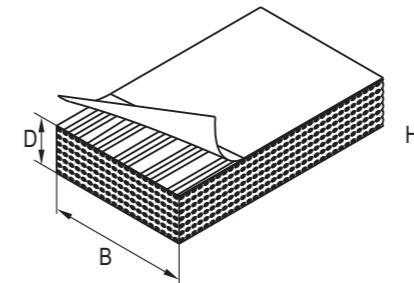

非延伸,自粘式,黑色发泡橡胶密封条
Cell sponge rubber, black with strtch eliminating self-adhesive backing

宽度 Width B	厚度 Depth D	天然橡胶 EPDM	氯丁橡胶 CR
10	3	7301-1003	7302-1003
	4	7301-1004	7302-1004
	5	7301-1005	7302-1005
15	3	7301-1503	7302-1503
	4	7301-1504	7302-1504
	5	7301-1505	7302-1505
20	3	7301-2003	7302-2003
	4	7301-2004	7302-2004
	5	7301-2005	7302-2005
25	3	7301-2503	7302-2503
	4	7301-2504	7302-2504
	6	7301-2506	7302-2506
30	3	7301-3003	7302-3003
	4	7301-3004	7302-3004
	5	7301-3005	7302-3005

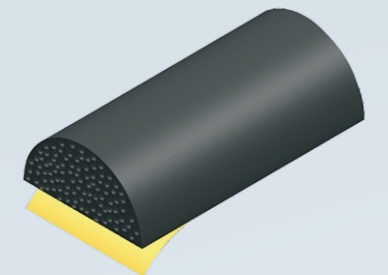
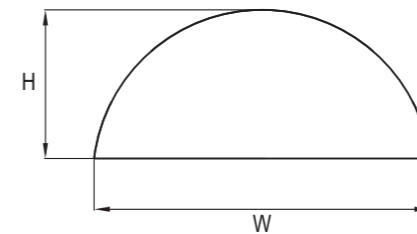

非延伸,自粘式,黑色发泡橡胶密封条
Cell sponge rubber, black with strtch eliminating self-adhesive backing

高度 H	宽度 W	天然橡胶 EPDM
7	16	7303-0716
5	16	7303-0516
3	16	7303-0316
8	16	7303-0816
7	10	7303-0710
12	10	7303-1210